

SNYDER



Equipment, Inc.

Storing, Rolling, Lifting since 1947

PRODUCT INFORMATION

Auth-Florence F-Spec. cluster box units

2946 Larimer St. Denver, CO 80205
303-295-1100 / 800-373-7693
FAX 303-295-2464
Email info@snyderequipment.com
www.snyderequipment.com

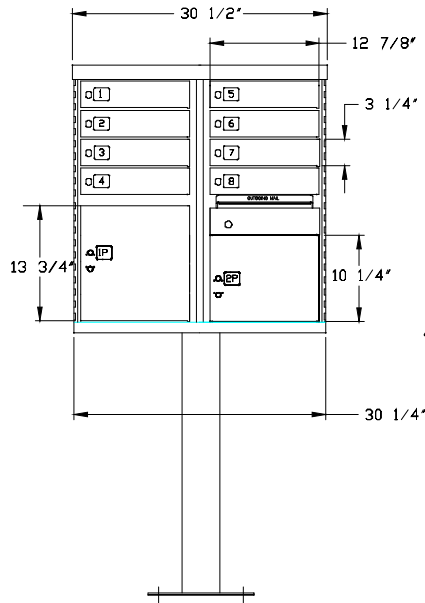

(FRONT VIEW)

1570-8

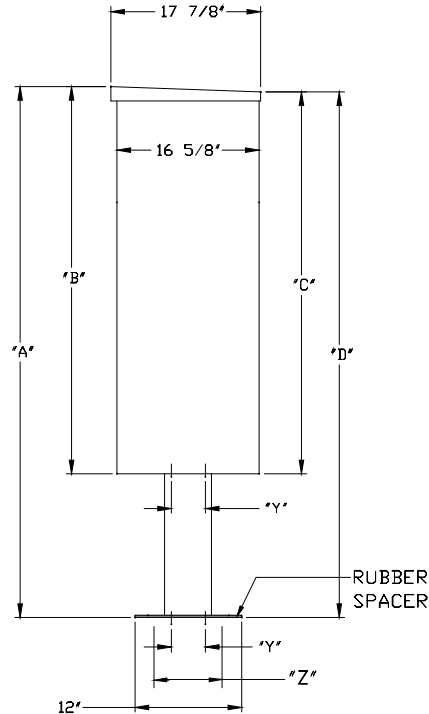
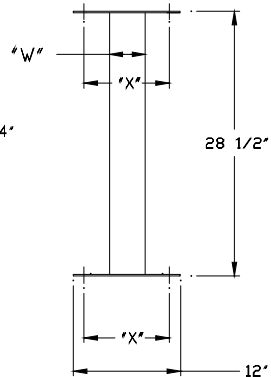

(SIDE VIEW)
SIDE VIEW

H.D. PEDESTAL

TYPE	DIM "W"	DIM "X"	DIM "Y"	DIM "Z"
TYPE II	4"	10"	4"	6"
TYPE III	4"	10"	4"	6"

UNIT TYPES

TYPE	DIM "A"	DIM "B"	DIM "C"	DIM "D"	PEDESTAL
TYPE I	62 11/16"	34 3/16"	33 5/16"	61 13/16"	28 1/2"
TYPE II	62 11/16"	34 3/16"	33 5/16"	61 13/16"	28 1/2"
TYPE III	62 9/16"	48 3/16"	47 1/4"	61 5/8"	14 3/8"
TYPE IV	62 9/16"	48 3/16"	47 1/4"	61 5/8"	14 3/8"

CUSTOMER CBU-F

JOB

AUTH AF FLORENCE MANUFACTURING COMPANY 5935 CORPORATE DRIVE MANHATTAN KANSAS 66503	DATE 6/16/05	P.O. NO. --
	SCALE 1/16:1	ORDER NO. --
DRAWING NUMBER CBU-F	DRAWN BY RT	CHECKED

NOTES:

- (1)1570-8 TYPE I CLUSTER BOX UNITS WITH (1)28" PEDESTAL(S).

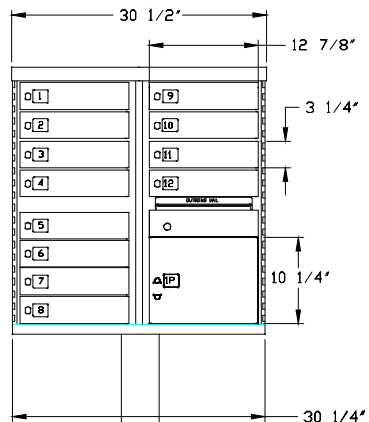

(FRONT VIEW)

1570-12

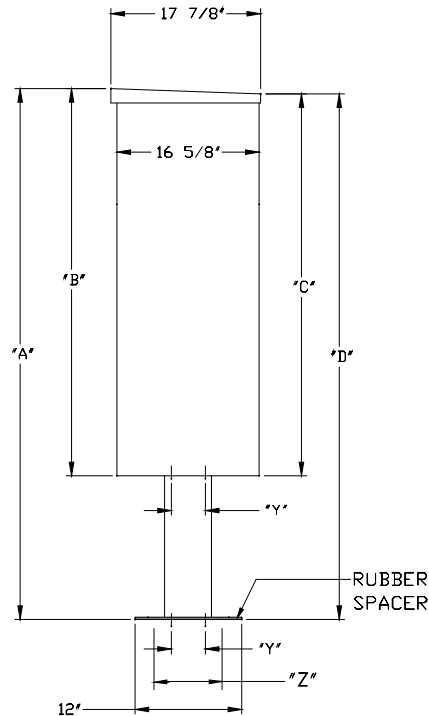
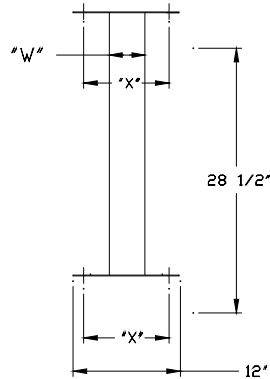

(SIDE VIEW)
SIDE VIEW

RUBBER SPACER

H.D. PEDESTAL

TYPE	DIM "W"	DIM "X"	DIM "Y"	DIM "Z"
TYPE II	4"	10"	4"	6"
TYPE III	4"	10"	4"	6"

UNIT TYPES

TYPE	DIM "A"	DIM "B"	DIM "C"	DIM "D"	PEDESTAL
TYPE I	62 11/16"	34 3/16"	33 5/16"	61 13/16"	28 1/2"
TYPE II	62 11/16"	34 3/16"	33 5/16"	61 13/16"	28 1/2"
TYPE III	62 9/16"	48 3/16"	47 1/4"	61 5/8"	14 3/8"
TYPE IV	62 9/16"	48 3/16"	47 1/4"	61 5/8"	14 3/8"

CUSTOMER CBU-F

JOB

AUTH AF FLORENCE
MANUFACTURING COMPANY
5935 CORPORATE DRIVE
MANHATTAN KANSAS 66503

DATE 6/16/05 P.O. NO. --
SCALE 1/16:1 ORDER NO. --
DRAWING NUMBER CBU-F DRAWN BY RT CHECKED

NOTES:

1. (1)1570-12 TYPE II CLUSTER BOX UNITS WITH (1)28" PEDESTAL(S).

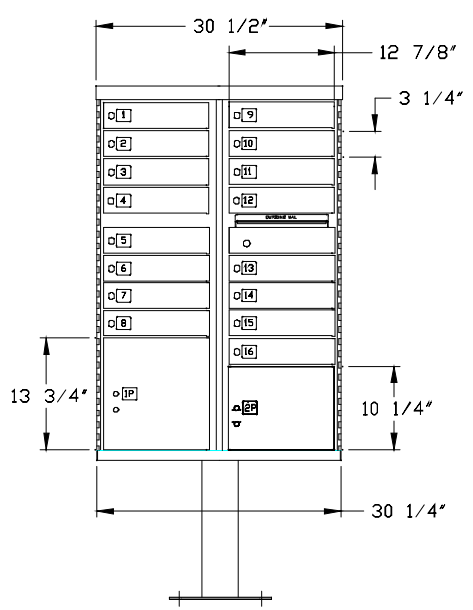

(FRONT VIEW)

1570-16

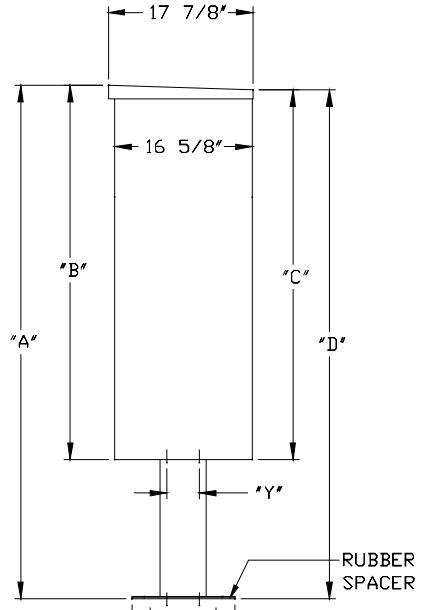

(SIDE VIEW)
SIDE VIEW

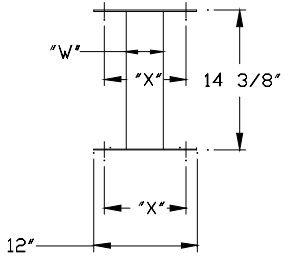

UNIT TYPES

TYPE	DIM "A"	DIM "B"	DIM "C"	DIM "D"	PEDESTAL
TYPE I	62 11/16"	34 3/16"	33 5/16"	61 13/16"	28 1/2"
TYPE II	62 11/16"	34 3/16"	33 5/16"	61 13/16"	28 1/2"
TYPE III	62 9/16"	48 3/16"	47 1/4"	61 5/8"	14 3/8"
TYPE IV	62 9/16"	48 3/16"	47 1/4"	61 5/8"	14 3/8"

H.D. PEDESTAL

TYPE	DIM "W"	DIM "X"	DIM "Y"	DIM "Z"
TYPE II	4"	10"	4"	6"
TYPE III	4"	10"	4"	6"

CUSTOMER					
CBU-F-16					
JOB					
1570-F BOX					
AUTH AF FLORENCE MANUFACTURING COMPANY 6935 CORPORATE DRIVE MANHATTAN KANSAS 66503		DATE	7/6/05	P.O. NO.	
		SCALE	1/16:1	ORDER NO.	
DRAWING NUMBER 1570-16		DRAWN BY		CHECKED	
		R.T.			

1. (1)1570-16 TYPE III CLUSTER BOX UNITS WITH (1)14" PEDESTAL(S).

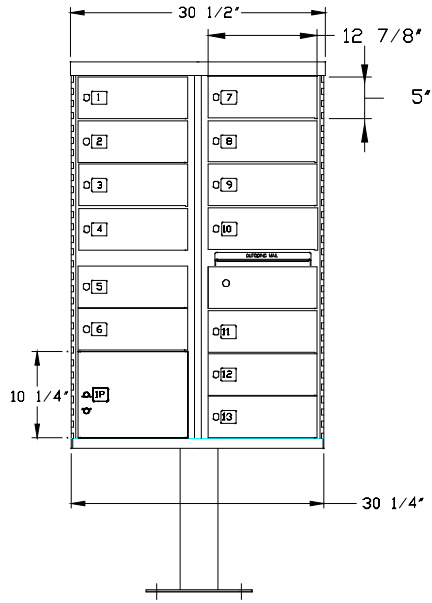

(FRONT VIEW)

1570-13

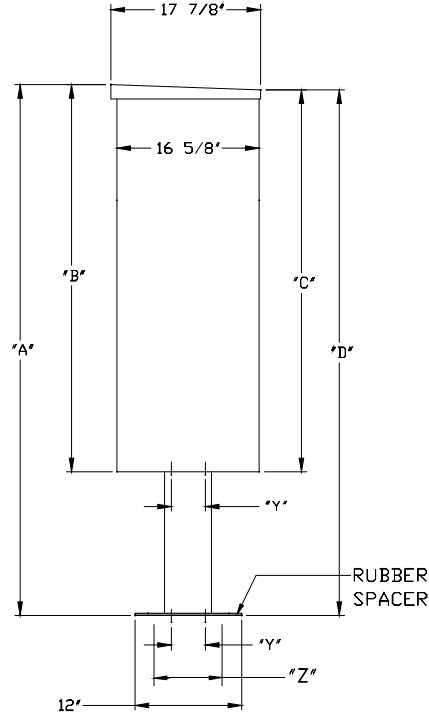
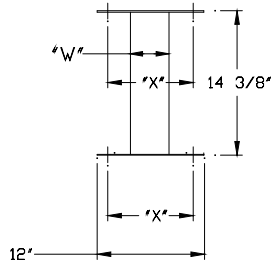

(SIDE VIEW)
SIDE VIEW

H.D. PEDESTAL

TYPE	DIM "W"	DIM "X"	DIM "Y"	DIM "Z"
TYPE II	4"	10"	4"	6"
TYPE III	4"	10"	4"	6"

UNIT TYPES

TYPE	DIM "A"	DIM "B"	DIM "C"	DIM "D"	PEDESTAL
TYPE I	62 11/16"	34 3/16"	33 5/16"	61 13/16"	28 1/2"
TYPE II	62 11/16"	34 3/16"	33 5/16"	61 13/16"	28 1/2"
TYPE III	62 9/16"	48 3/16"	47 1/4"	61 5/8"	14 3/8"
TYPE IV	62 9/16"	48 3/16"	47 1/4"	61 5/8"	14 3/8"

1. (1)1570-13 TYPE IV CLUSTER BOX UNITS WITH (1)14" PEDESTAL(S).

CUSTOMER		CBU-F	
JOB			
DATE	6/16/05	P.O. NO.	--
SCALE	1/16:1	ORDER NO.	--
DRAWING NUMBER	CBU-F	DRAWN BY	RT
		CHECKED	